

DOCK SEAL - D-350-20

APPROX WEIGHT: 157.07 lbs.
 DOES NOT INCLUDE WEIGHT OF POWER OR PACKAGING!!!

*** ANY ADDITIONS, DELETIONS, OR OMISSIONS MUST BE CORRECTED ON THIS DRAWING AS THIS DRAWING WILL BE CONSIDERED ALL INCLUSIVE ***

ALL GRAPHICS PROVIDED ARE FOR REFERENCE ONLY. IF CERTAIN DIMENSIONS ARE CRITICAL PLEASE VERIFY THOSE DIMENSIONS WITH YOUR SALESPERSON

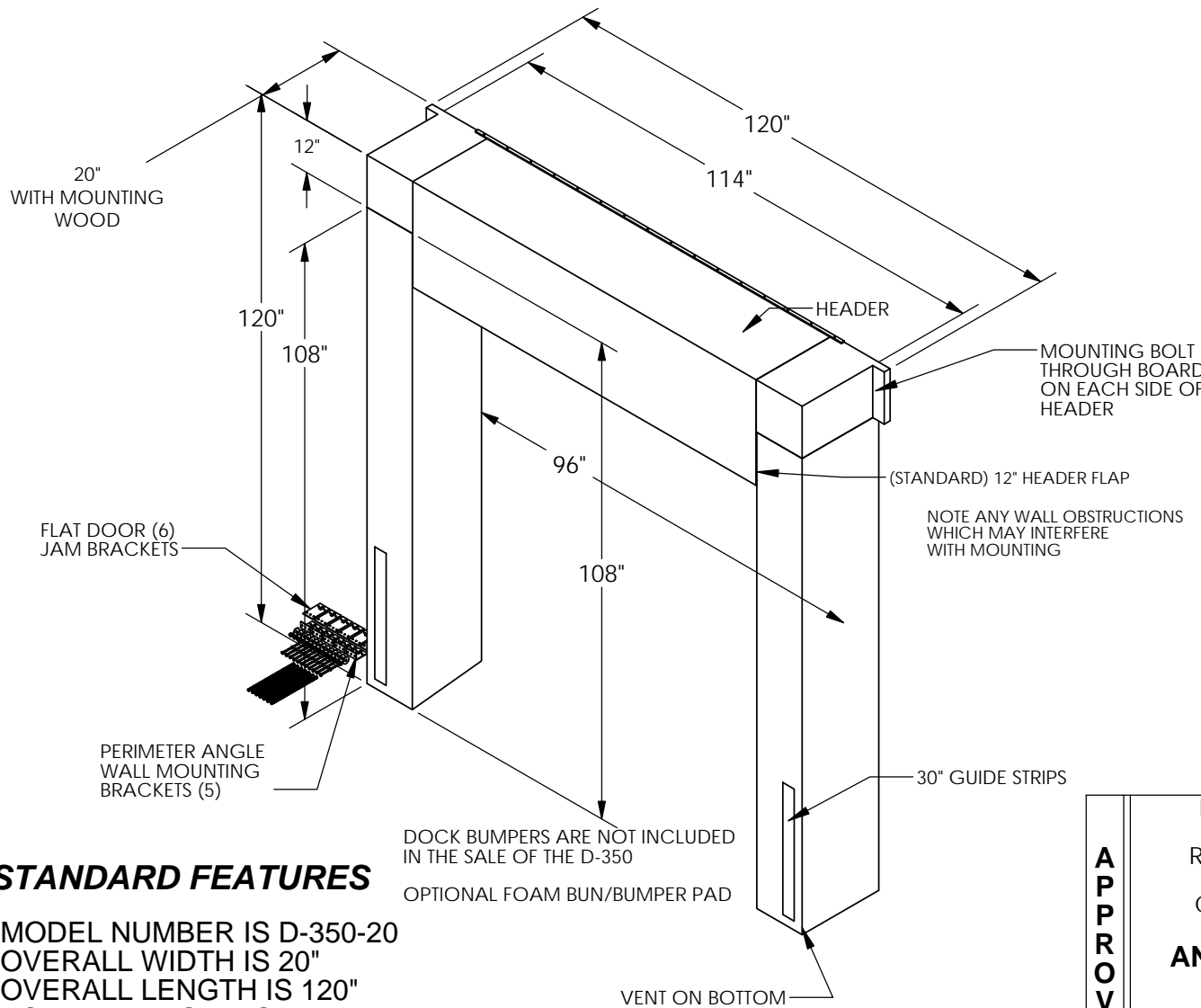

*OPTIONS:

- FULL HEIGHT GUIDE STRIPS, (30" STANDARD)
 - 18" HIGH HEADER (12 STANDARD)
 - 12" HEADER FLAT
 - BOTTOM FOAM BUN / BUMPER PAD
 - 54 OUNCE FACING
 - SLOPED VERTICAL SIDES DOR INCLINED OR DECLINED DOCK APPROACH
 - ARMOUR PLEATS
 - TOP THREE FEET 8" EXPOSURE
 - FULL HEIGHT 8" EXPOSURE
 - FULL HEIGHT 4" EXPOSURE (MOST PROTECTION)
- *AVAILABLE AT ADDITIONAL COSTS

UNIT IS SPECIAL AND NON RETURNABLE

DIMENSION TOLERANCE $\pm 1/4"$

APPROVAL	I, THE UNDERSIGNED, AGREE THAT THE PRODUCT AS REPRESENTED SATISFIES DESIGN AND DIMENSION REQUIREMENTS. I ALSO ACKNOWLEDGE MY DUTY TO CONFIRM PRODUCT AND INSTALLATION COMPLIANCE WITH ALL APPLICABLE FEDERAL, STATE AND LOCAL REGULATIONS AND STANDARDS.	
	ANY MODIFIED UNITS ARE NON-RETURNABLE	
	[] As drawn [] As marked	
	Signed: _____	Date: _____
Printed Name: _____		
LEAD TIME WILL START UPON RECEIPT OF SIGNED APPROVAL DRAWING		

STANDARD FEATURES

MODEL NUMBER IS D-350-20
 OVERALL WIDTH IS 20"
 OVERALL LENGTH IS 120"
 USABLE LENGTH IS 96"
 OVERALL HEIGHT IS 120"
 USEABLE HEIGHT IS 108"

SPECIAL FEATURES

NONE

** ANY ADDITIONS, DELETIONS, OR OMISSIONS MUST BE CORRECTED ON THIS DRAWING, AS THIS DRAWING WILL BE CONSIDERED ALL INCLUSIVE. **

FOR INTERNAL USE ONLY PROJECT SIGN OFF	
SALES	
ENG.	
FAB.	
POWER	

DISTRIBUTOR'S NAME:		P.O.#
VESTIL MANUFACTURING		X
DRAWN BY: BCN		W.O.#
DATE: 3/7/2016		X
REFERENCE: X	SCALE: 1:32	SALES: X
QUOTED LEAD TIME: X	QUOTE #	FILE NAME:
	X	35-007-031