

HINGED, 3 RIB, SINGLE GUARD RAIL GATE - GR-F3R-GBS-3-YL

APPROX WEIGHT: 53.30 lbs.
 DOES NOT INCLUDE WEIGHT OF POWER OR PACKAGING!!!

*** ANY ADDITIONS, DELETIONS, OR OMISSIONS MUST BE CORRECTED ON THIS DRAWING AS THIS DRAWING WILL BE CONSIDERED ALL INCLUSIVE ***

ALL GRAPHICS PROVIDED ARE FOR REFERENCE ONLY. IF CERTAIN DIMENSIONS ARE CRITICAL PLEASE VERIFY THOSE DIMENSIONS WITH YOUR SALESPERSON
 THE ACTUAL PRODUCT MAY VARY FROM THE IMAGES SHOWN ON WEBSITE. PRODUCTS AND SPECIFICATIONS SUBJECT TO CHANGE WITHOUT NOTICE.

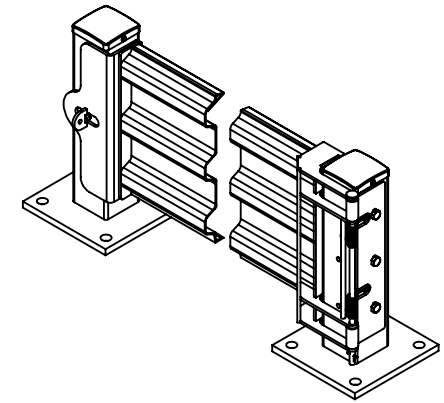
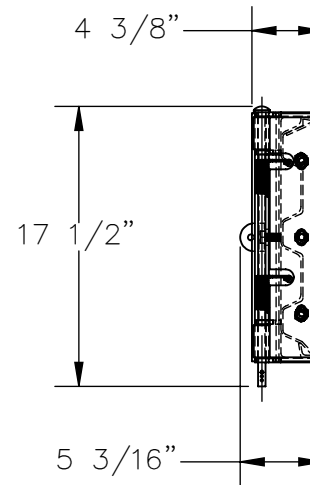
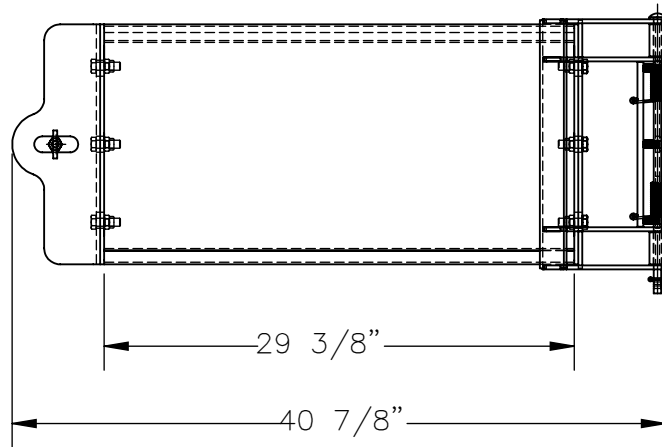

NOTE: POSTS NOT INCLUDED

DIMENSION TOLERANCE ± 1/4"

STANDARD FEATURES

- MODEL NUMBER IS: GR-F3R-GBS-3-YL
- OVERALL WIDTH IS: 40 7/8"
- USABLE WIDTH IS: 29 3/8"
- OVERALL LENGTH IS: 5 3/16"
- OVERALL HEIGHT IS: 17 1/2"
- GUARD RAIL IS TOUGH BAKED IN POWDER COATED YELLOW FINISH
- BRACKETS ARE TOUGH BAKED IN POWDER COATED BLACK FINISH
- INCLUDES HARDWARE

SPECIAL FEATURES

NONE

APPROVAL

I, THE UNDERSIGNED, AGREE THAT THE PRODUCT AS REPRESENTED SATISFIES DESIGN AND DIMENSION REQUIREMENTS. I ALSO ACKNOWLEDGE MY DUTY TO CONFIRM PRODUCT AND INSTALLATION COMPLIANCE WITH ALL APPLICABLE FEDERAL, STATE AND LOCAL REGULATIONS AND STANDARDS.
UNITS REQUIRING APPROVAL DRAWINGS OR MODIFIED ARE NON-RETURNABLE
 As drawn As marked

Signed: _____ Date: _____

Printed Name: _____

LEAD TIME WILL START UPON RECEIPT OF SIGNED APPROVAL DRAWING

DISTRIBUTOR'S NAME:		P.O.#
VESTIL MANUFACTURING		X
DRAWN BY: JGP		W.O.#
DATE: 4/20/2021		X
REFERENCE: X	SCALE: 1:12	SALES: X
QUOTED LEAD TIME: X	QUOTE #	FILE NAME:
	X	23-007-818